

MODEL EMBER VISION 100 AND 200 SERIES

EMBER VISION 100 SERIES VENT-FREE OR VENTED 24”(OAK or PINE) GAS LOG SET

EMBER VISION 200 SERIES VENT-FREE OR VENTED 30”(OAK) GAS LOG SET

FOR NATURAL OR LIQUID PETROLEUM (L.P.)
WITH OPTIONAL HEAT SHIELD MODEL 19HS



WARNING: If the following information in this manual is not followed exactly, a fire or explosion may result causing property damage, personal injury, or loss of life.

-DO NOT STORE OR USE GASOLINE OR OTHER FLAMMABLE VAPORS AND LIQUIDS IN THE VICINITY OF THIS OR ANY OTHER APPLIANCE.

-WHAT TO DO IF YOU SMELL GAS

- * Do not try to light any appliance.
- * Do not touch any electrical switch; do not use any phone in your building.
- * Immediately call your gas supplier from a neighbor's phone.
Follow the gas supplier's instructions.
- * If you cannot reach the gas supplier, call the fire department.

-Installation and service must be performed by a qualified installer, service agency, or the gas supplier.

-This appliance is intended for supplemental heating.

This is an unvented and vented gas-fired heater. It uses air (oxygen) from the room in which it is installed. Provisions for adequate air for combustion and ventilation must be provided. Refer to Section V, page 20.

This appliance may be installed in an aftermarket, permanently located, manufactured (mobile) home, where not prohibited by local codes.

This appliance is only for use with the type of gas indicated on the rating plate. This appliance is not convertible for use with other gases.

WARNING: This appliance is equipped for (natural or propane) gas. Field conversion is not permitted.

INSTALLER: Leave this manual with the appliance.

CONSUMER: Retain this manual for future reference.

TABLE OF CONTENTS

SECTION I: Safety Information.....	1
SECTION II: Residential Installation-Unvented Gas Logs	4
Clearances.....	5
Gas Connection.....	5
Preparing Log Kit	6
Log Placement	7
Gas Pressure Check	10
Lighting Instructions-Millivolt Valve (SIT).....	11
Flame Check	15
Heat Output.....	15
SECTION III: Installation-Heat Shield	16
Wiring Diagram	18
SECTION IV: Installation-After Market Mobile Home	20
SECTION V: Producing Adequate Air For Combustion And Ventilation	20
Ventilation Air For Combustion And Ventilation From Inside	23
Ventilation Air For Combustion And Ventilation From Outdoors	24
SECTION VI: Vented Logs	25
Important Safeguards.....	27
Cleaning.....	27
Troubleshooting.....	28
Servicing and Replacement Parts	33
Warranty	35
Owner Registration Card	Back Cover

SECTION I

SAFETY INFORMATION

WARNINGS

IMPORTANT: READ THIS OWNER'S MANUAL CAREFULLY AND COMPLETELY BEFORE TRYING TO ASSEMBLE, OPERATE, OR SERVICE THE APPLIANCE. IMPROPER USE OF THESE LOGS CAN CAUSE SERIOUS INJURY OR DEATH FROM BURNS, FIRE, EXPLOSION, AND CARBON MONOXIDE POISONING.

- **NOTE: When burning any unit or appliance that combust fuel for heat, such as coal, oil, wood or natural and (L.P.) liquid petroleum gas. We highly recommend the use of smoke and carbon monoxide detectors in your home.**

Early signs of carbon monoxide poisoning resemble the flu, with headaches, dizziness, and/or nausea. If you have these signs, the heater may not be working properly. Get fresh air at once! Turn off gas. Have burner serviced. Some people (such as pregnant women, persons with heart or lung disease, persons with anemia, those under the influence of alcohol, and those at high altitudes) are more affected by carbon monoxide than others. Make certain you understand and read all **Warnings**. Keep this manual for reference. It is your guide to safe and proper operation of these logs.

1. Install log set only in a solid-fuel-burning masonry fireplace or U.L. listed pre-fabricated fireplace constructed of non-combustible materials.
2. The installation must conform with local codes or, in the absence of local codes, with the National Fuel Gas Code, **ANSI Z223.1/NFPA 54**.
3. This appliance may be installed in an After Market* Manufactured (Mobile) Home, where not prohibited by state or local codes.
(* After Market: Completion of sale, not for purpose of resale from the manufacturer.)

NOTE: This appliance is only for use with the type of gas indicated on the rating plate. This appliance is not convertible for use with other gases.

NOTE: See Section IV for Mobile Home Installation, and Section V for Air For Combustion And Ventilation.

IMPORTANT: VENT-FREE HEATERS ADD MOISTURE TO THE AIR. ALTHOUGH THIS IS BENEFICIAL, INSTALLING HEATER IN ROOMS WITHOUT ADEQUATE VENTILATION MAY CAUSE MILDEW TO FORM FROM TOO MUCH MOISTURE.

4. Never install the log set:
 - in a recreational vehicle.
 - where curtains, furniture, clothing, or other flammable objects are less than 42" from the front of the heater.
 - in high traffic areas or in windy areas.

NOTE: These log sets comply with both the **ANSI Z21.11.2b-2010** "Unvented Room Heater" and **ANSI Z21.60b-2004. CSA2.26b-2004** Decorative Appliance For "Solid Fuel Burning Fireplace".

WARNING: ANY CHANGE TO THIS HEATER OR ITS CONTROLS CAN BE DANGEROUS.

5. Two models are available. One specific model for propane (LP), and one for natural gas. Use the correct gas type for your home. This unit is not field convertible.
6. If these gas logs are for use with propane gas, do not place propane supply tank(s) inside any structure. Locate propane supply tank(s) outdoors.
7. If you smell gas:
 - Shut off gas supply.
 - Do not try to light any appliance.
 - Do not touch any electrical switch; do not use any phone in your building.
 - Immediately call your gas supplier from a neighbor's phone. Follow the gas supplier's instructions.
 - If you cannot reach your gas supplier, call the fire department.
8. This heater shall not be installed in unusually tight construction unless provisions are provided for adequate air for combustion and ventilation . See Section V “Producing Adequate Air For Combustion And Ventilation”, page 20.
9. Surface of gas logs becomes very hot when operating. Keep children and adults away from hot surface. Gas logs will remain hot for some time after shutdown. Allow surface to cool before touching.
10. Never place any objects on these gas logs.
11. These gas logs **MUST NOT BE USED** with glass doors in the closed position.
12. If equipped, fresh air damper must be closed permanently.
13. Keep appliance area clean and free from combustible materials, gasoline, and other flammable vapors and liquids. Keep burner and control compartment clean.
See Installation and Operating Instructions accompanying heater.
14. If burner shuts off, do not relight until you provide fresh outside air. If burner keeps shutting off, have unit serviced.
15. An unvented room heater having input rating of more than 10,000 BTU per hour shall not be installed in a bedroom or bathroom.
16. Maintain clearance around air openings.

WARNING

**This appliance is equipped for (natural or propane) gas.
Field conversion is not permitted.**

17. Do not use the appliance if any part has been under water. Immediately call a qualified service technician to inspect the appliance and to replace any part of the control system and any gas control which has been under water.

18. Turn off the gas logs and let cool before servicing.

19. The logs are made of light weight refractory. Hold both ends of the logs when removing or replacing.

20. Make sure any safety screen or guard (if any) that was removed for servicing is in place before operating gas logs.

21. Strong drafts, such as a ceiling fan placed directly in front of the fireplace, may create sooting. Sooting may discolor walls.

22. Installation and repair should be done by a qualified service person. The heater and the gas logs should be inspected before use and at least annually by a professional service person. More frequent cleaning may be required due to excessive lint from carpeting, bedding materials, etc. It is important that the control compartment, burners, and circulating air passageways of these gas logs be kept clean and clear.

23. Do not use these gas logs for burning trash or cooking. Never place matches, paper, garbage, or any other material on top of logs or into the flames.

24. Do not install or operate these gas logs in areas where impurities in the air exist (such as tobacco smoke and heavy cooking grease). Particles from impurities may discolor walls.

25. The appliance and its individual shutoff valve must be disconnected from the gas supply piping system during any pressure testing of that system at test pressures in excess of 1/2 psi (3.5 kPa).

26. The appliance must be isolated from the gas piping system by closing its individual manual shut off valve during any pressure testing of the gas supply piping system at test pressures equal to or less than 1/2 PSIG.

27. Any outside air ducts and/or ash dumps in the fireplace shall be permanently closed at time of appliance installation.

28. Due to high temperatures, the appliance should be located out of traffic and away from furniture and draperies.

29. Do not place clothing or other flammable material on or near the appliance.

WARNING: State or local codes may only allow operation of this appliance in a vented configuration. Check your state on local codes.

SECTION II

RESIDENTIAL INSTALLATION OF GAS LOGS FIREPLACE PREPARATION

The fireplace needs to be prepared before installing the gas logs.

- A. Turn off the gas supply to the fireplace.
- B. Any outside air ducts on the fireplace shall be permanently closed at the time of the appliance installation.

“WARNING: BEFORE INSTALLING IN A SOLID FUEL BURNING FIREPLACE, THE CHIMNEY FLUE AND FIREBOX MUST BE CLEANED OF SOOT, CREOSOTE, ASHES AND LOOSE PAINT BY A QUALIFIED CHIMNEY CLEANER.”

“WARNING: DO NOT ALLOW FANS TO BLOW DIRECTLY INTO THE FIREPLACE. AVOID ANY DRAFTS THAT ALTER BURNER FLAME PATTERN.”

LOCATION

Centrally locate the gas logs in the fireplace. Place them deep enough into the fireplace to accomplish adequate draft (if use as a vented gas log set is planned). Ensure that the front of the logs sit inside the front edge of the fireplace.

For your convenience, we have furnished two holes in the rear bottom bar of the burner base to fasten it to the floor if you deem it necessary.

NOTE: IF THE EXISTING FIREPLACE IS EQUIPPED WITH A SCREEN IT MUST BE IN PLACE WHEN THE APPLIANCE IS OPERATING. THE SCREEN SHALL HAVE ADEQUATE OPENING (S) FOR INTRODUCTION OF AIR FOR COMBUSTION AND VENTILATION.

NOTE: MAINTAIN PROPER CLEARANCE FOR PURPOSE OF SERVICING, PROPER INSTALLATION, AND OPERATION.

NOTE: WHEN THE APPLIANCE IS INSTALLED ON CARPETING, TILE OR OTHER COMBUSTIBLE MATERIAL, OTHER THAN WOOD FLOORING, THE APPLIANCE SHALL BE INSTALLED ON A METAL OR WOOD PANEL EXTENDING THE FULL WIDTH AND DEPTH OF THE APPLIANCE.

Mantel Minimum Clearances for a listed Zero Clearance Firebox or a Masonry Fireplace.

Minimum Clearances With Canopy

* **WARNING:** Canopy model number MAPSFPC must be used at the fireplace opening. (Can be obtained from your local dealer or purchased from the factory.)

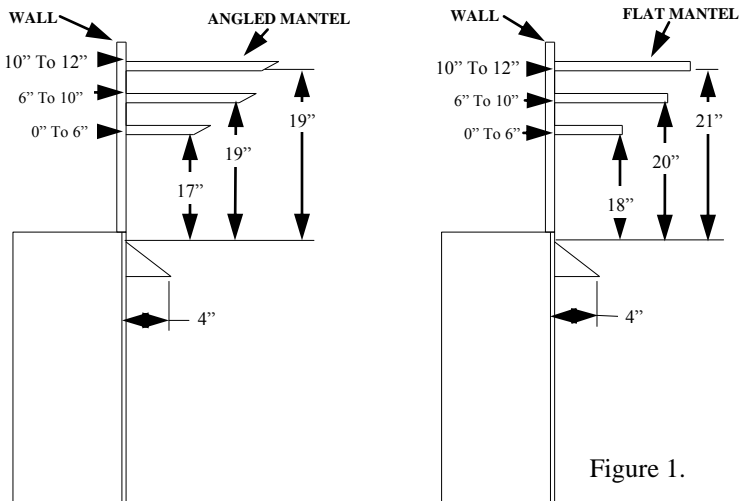
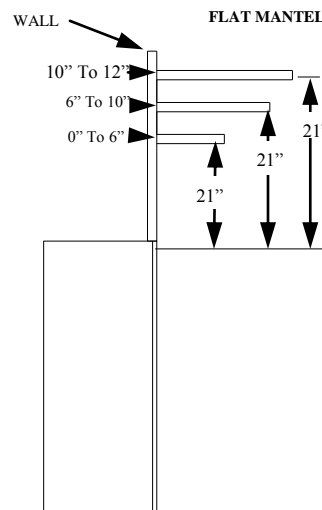

Figure 1.

Minimum Clearances Without Canopy



WARNING: THIS APPLIANCE IS FOR INSTALLATION ONLY IN A SOLID FUEL BURNING MASONRY OR UL127 FACTORY BUILT FIREPLACE OR IN A LISTED VENTLESS FIREBOX ENCLOSURE.

IT HAS BEEN DESIGN CERTIFIED FOR THESE INSTALLATIONS. EXCEPTION: DO NOT INSTALL THIS APPLIANCE IN A FACTORY BUILT FIREPLACE THAT INCLUDES INSTRUCTIONS STATING IT HAS NOT BEEN TESTED OR SHOULD NOT BE USED WITH UNVENTED GAS LOGS.

INSTALLATION AND CLEARANCES

To ensure a safe installation into an existing solid fuel burning fireplace, the following instructions must be carefully followed.

NOTE: Gas control knobs are located on right side facing unit.

1) Side wall Minimum Clearances:

Clearance from the right and left side of the fireplace opening to any adjacent combustible wall should not be less than 4".

2) Ceiling Clearances:

The ceiling height should not be less than 42" from the top of the fireplace opening.

3) Mantel Minimum Clearances:

For clearances from top of heater to mantel or mantel supports see Figure 1.

4) Front Minimum Clearances:

No objects should be placed within 24" from the front of the fireplace opening.

MINIMUM FIREPLACE DIMENSIONS FOR EMBER VISION 100 AND 200 SERIES LOG SET MANUFACTURED BY NEW BUCK CORPORATION FOR SOLID FUEL BURNING FIREPLACE OR MASONRY FIREPLACE AND PREFAB OR MANUFACTURED FIREPLACES.

	HEIGHT OF OPENING	WIDTH OF OPENING AT FRONT	WIDTH AT REAR	DEPTH OF FIREPLACE
MODEL 100 E.V. 24" Logs	17"	32"	26"	15"
MODEL 200 E.V. 30" Logs	17"	34"	26"	15"

NOTE: When using logset with The Model 19HS heat shield see page 16 for clearances.

WARNING: ANY CHANGE TO THIS HEATER OR ITS CONTROLS CAN BE DANGEROUS.

WARNING: Cutting any sheet metal parts of the solid-fuel burning fireplace or listed ventless firebox enclosure in which the unvented fireplace insert (log set) is to be installed is prohibited.

NOTE: Smoke shelves, shields and baffles may be removed if attached by mechanical fasteners. NOTE: Refractory, glass doors, screen rails, screen mesh and solid-fuel log grates (if applicable) can be removed from the fire place before installing the unvented fireplace insert.

WARNING: Any glass doors shall be fully opened when the appliance is in operation.

GAS CONNECTION

Check gas type. Use only the type of gas indicated on the valve rating plate. If the type of gas listed on the plate is not your type of gas supply, DO NOT INSTALL. Contact your dealer for proper model.

Always use an external regulator for all LP heaters to reduce the supply tank pressure to a maximum of 13" W.C. This is in addition to the regulator furnished with the heater.

Warning: Connection directly to an unregulated LP tank can cause an explosion.

The normal gas connection is 3/8" N.P.T. made at the right side facing the log set. If a left side connection is desired, the connecting pipe may be routed under the rear of the burner base to terminate at the right hand side for connection to the inlet of the valve.

NOTE: The connecting pipe must be internally tinned copper tubing for use with natural gas. Test for leaks using a solution of soap and water after completing the connection. **DO NOT USE OPEN FLAME.**

NOTE: If the factory-built fireplace has no gas access hole(s) provided, an access hole of 1.5 inch (37.5mm) diameter or less may be drilled through the lower sides or bottom of the fire box in a proper workmanlike manner. This access hole must be plugged with non-combustible insulation after the gas supply line has been installed.

PREPARING LOG KIT

Open the cartons containing the Burner Base and the logs. Inside one of the cartons you will find the Burner Base. The logs are boxed separately.

MODEL E.V. 200 SERIES: 1)Rear Log, 2)Middle Log, 3)Left Top Middle Log, 4)Right Top Middle Log 5)Left Front Log 6)Right Front Log 7)Glowing Embers in front of 5 & 6 logs.

WARNING: POSITIONING OF LOGS IS VERY CRITICAL (See Figure 2). Page 10.

LOG PLACEMENT FOR E.V.100 Series 24" OAK or PINE LOG SET and 200 Series 30" OAK LOG SET:

- 1) Place rear log #1 on rear log supports. The log has alignment notches on each rear corner.
- 2) Place Middle log #2 in front of the rear burner tube and then move the log forward. The log should seat just behind the brass knob(s), located in the middle section of the base between the rear burner tube and the front burner pan.
- 3) Place Left Top Middle log #3 on the pins located on the left top section of Middle log #2.
- 4) Place Right Top Middle log #4 on the pins located on the right top section of Middle log #2.
- 5) Place Left Front log #5 on the locator pins located on the left middle section of the front burner pan.
- 6) Place Right Front log #6 on the locator pins located on the right middle section of the front burner pan.
- 7) Provided with your log set is a package of Glowing Embers (rock wool). Open the package and tare off small pieces of the wool material and place it over the small holes (ports) located on the front burner pan in front of logs #5 and #6. Cover the entire section of holes (ports). ***Replacement of loose (Glowing Embers) must be purchased from the original manufacturer and application of excess loose material may adversely affect performance of the heater.**

NOTE: Wash your hands immediately after coming in contact with the wool material. The wool can cause slight itching or burning, avoid any contact with eyes.

WARNING: All previously applied loose material must be removed prior to replacement.

- 8) Provided with the OAK log sets are two logs, #8 and #9 logs. Place #8 against the left front edge of the front burner and #9 against the right front edge. Each log has a groove on the back side to place the log. These logs do not have to be used if not desired.

Solid fuels shall not be burned in the same fireplace where an unvented room heater has been installed.

NOTE: The following label has been provided with this appliance and must be read and then attached to the floor of the fireplace or firebox area beneath the appliance. The label is a peel and stick label. Make sure the area is cleaned before attaching the label to it.

WARNING: This solid-fuel burning fireplace or listed ventless enclosure has been converted for use with an unvented fireplace insert only. A solid-fuel burning fireplace cannot be used for burning wood or solid fuels unless all original parts have been replaced, and the fireplace re-approved by the authority having jurisdiction. A ventless firebox enclosure cannot be used with an unvented gas log unless all original parts have been replaced, and the ventless firebox enclosure re-approved by the authority having jurisdiction.

LOG PLACEMENT FOR EMBER VISION 100 SERIES/ 24" LOG SET

OAK LOGS SHOWN.

#1

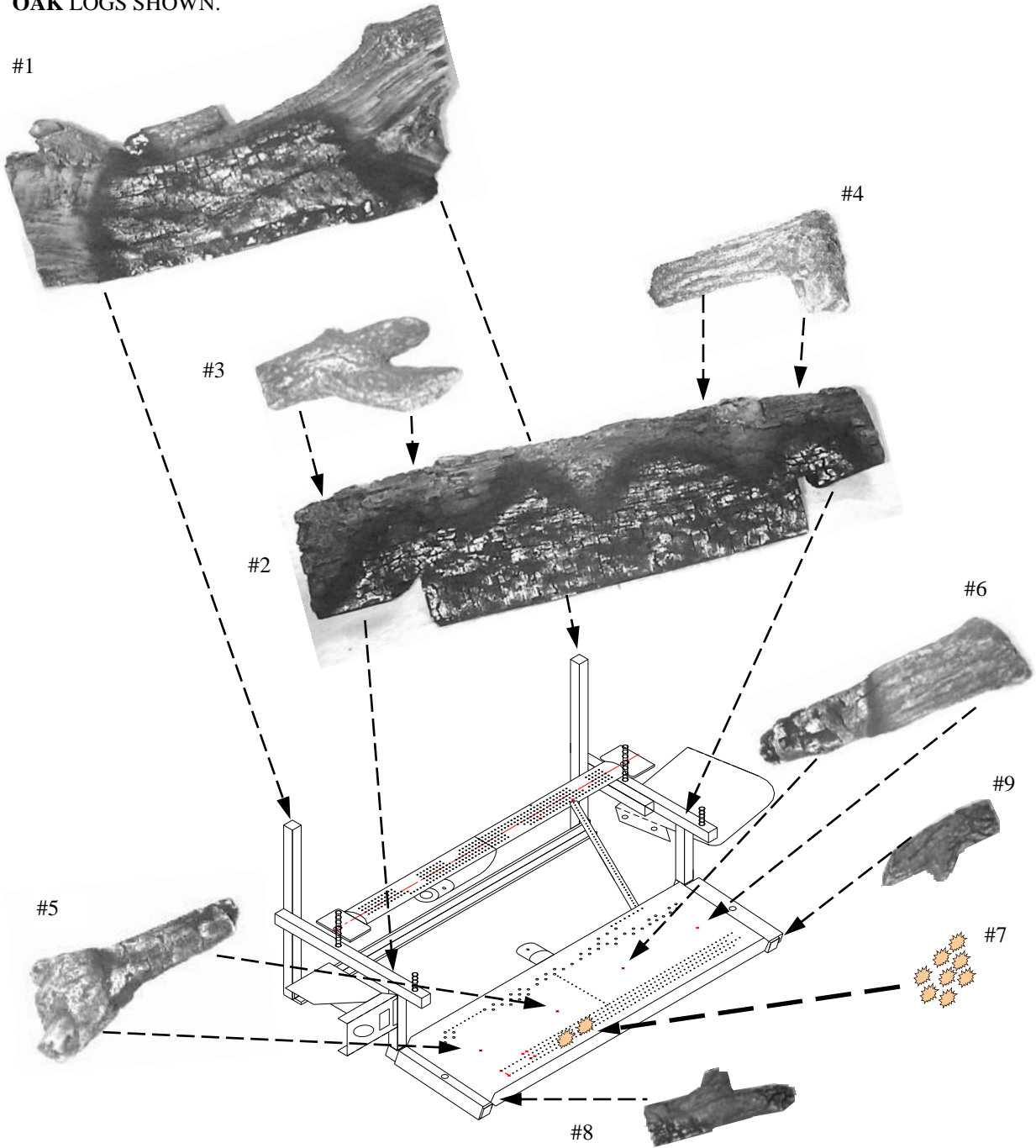

Apply loose material per instructions manual. **DO NOT** apply extra material or material not supplied with the heater. Replace only with material from your Buck Stove dealer or from New Buck Corporation.

WARNING: Failure to position the parts in accordance with these diagrams or failure to use only parts specifically approved with this heater may result in property damage or personal injury.

LOG PLACEMENT FOR EMBER VISION 100 SERIES/ 24" LOG SET

PINE LOGS SHOWN.

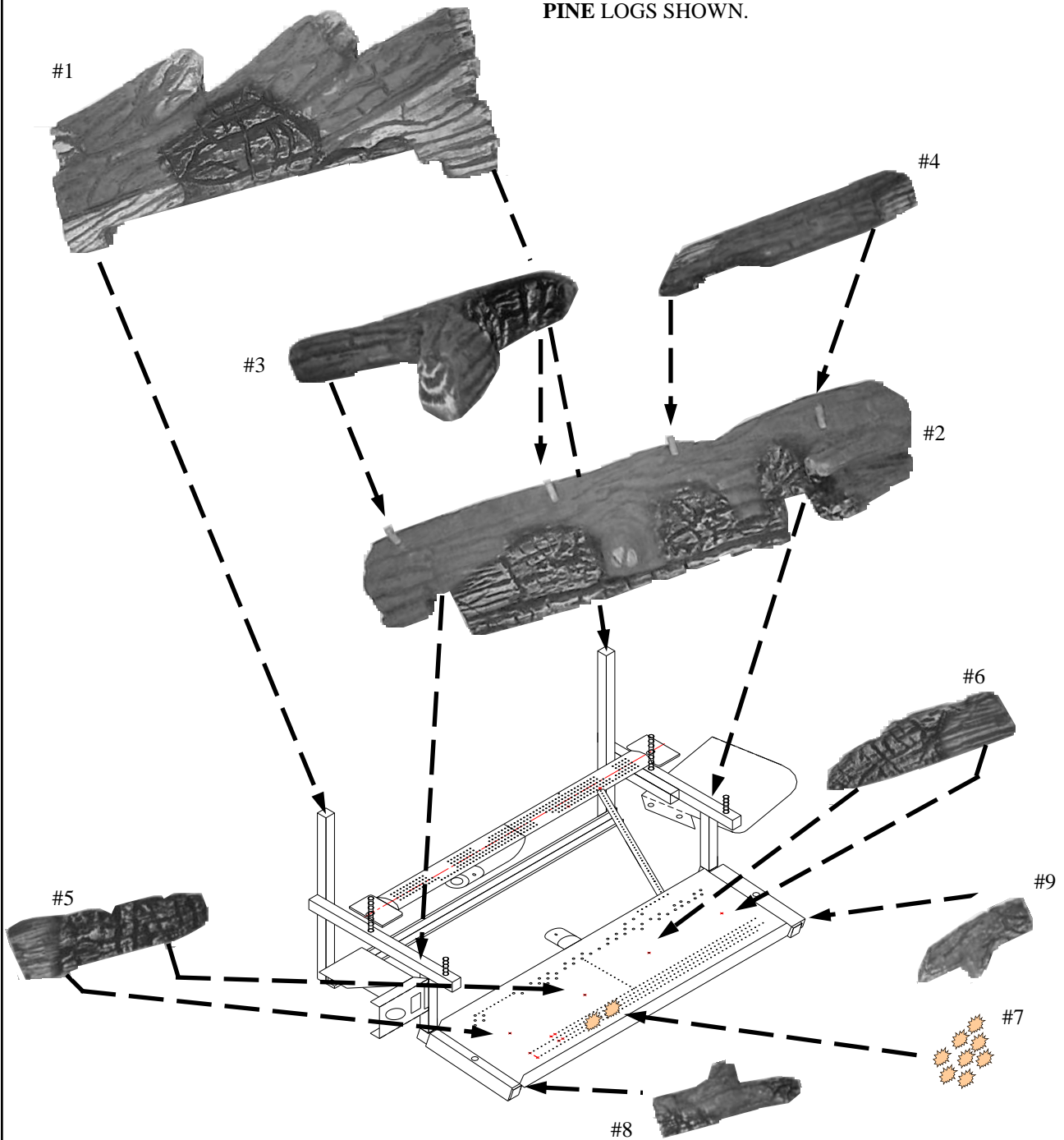

Apply loose material per instructions manual. **DO NOT** apply extra material or material not supplied with the heater. Replace only with material from your Buck Stove dealer or from New Buck Corporation.

WARNING: Failure to position the parts in accordance with these diagrams or failure to use only parts specifically approved with this heater may result in property damage or personal injury.

LOG PLACEMENT FOR EMBER VISION 200 SERIES 30" LOG SET

OAK LOGS SHOWN.

#1

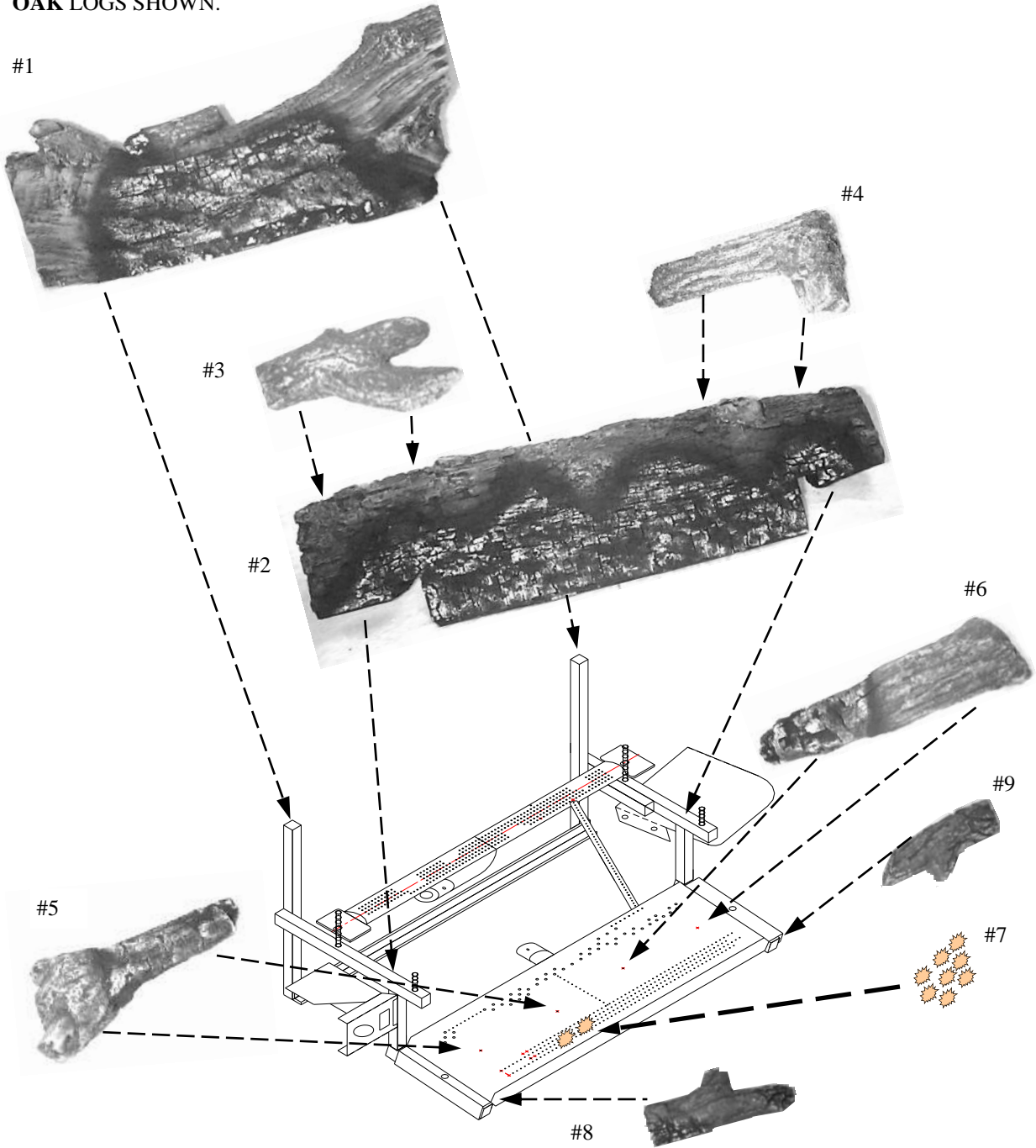

Apply loose material per instructions manual. **DO NOT** apply extra material or material not supplied with the heater. Replace only with material from your Buck Stove dealer or from New Buck Corporation.

WARNING: Failure to position the parts in accordance with these diagrams or failure to use only parts specifically approved with this heater may result in property damage or personal injury.

EMBER VISION SERIES/24" PINE LOG SET SHOWN

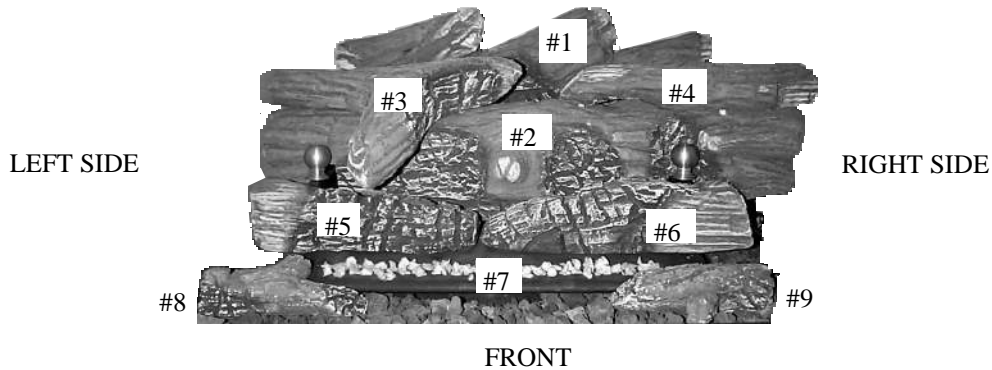

Figure 2.

GAS PRESSURE CHECK

Check the inlet pressure to the burner to ensure that it is as shown in the table below. **NOTE:** The pressure check point is located on right side of valve facing the burner.

The appliance and its appliance main gas valve must be disconnected from the gas supply piping system during any pressure testing of that system at test pressures in excess of 1/2 psi (3.5kPa).

The appliance must be isolated from the gas supply piping system by closing its equipment shut-off valve during any pressure testing of the gas supply piping system at test pressures equal to or less than 1/2 psi (3.5 kPa).

MODEL	EMBER VISION 100 AND 200 SERIES	
Gas	Natural	Propane (LP)
Maximum Heat Input	40,000	40,000
Minimum Heat Input	31,000	33,000
Gas Inlet Pressure:		
Maximum	10.5 ins. W.C.	13.0 ins. W.C.
Minimum	4.5 ins. W.C.	10.5 ins. W.C.
Manifold Pressure	3.5 ins. W.C.	10.0 ins. W.C.

NOTE: On initial installation it may be required to bleed out air in the gas lines. Do this by holding the control knob and turning the knob to the pilot position for about 30 seconds.

The pressure should be checked with the heater burning and the control set on high. After measuring the pressure, close pressure tap screw, ensuring there are no leaks. Regulator pressure check screw located above “OFF/ PILOT/ON” knob at right upper corner of valve.

WARNING
This appliance is equipped for (natural or propane) gas.
Field conversion is not permitted.

OPERATING INSTRUCTIONS

Before operating this appliance, proceed through the following checklist.

1. Read and understand these instructions before operating this appliance.
2. Check that there are no gas leaks. If you smell gas do not attempt to light this appliance.
3. Verify that log placement is correct.

LIGHTING INSTRUCTIONS SIT-MILLIVOLT VALVE FOR YOUR SAFETY READ BEFORE LIGHTING

WARNING: If you do not follow these instructions exactly, a fire or explosion may result causing property damage, personal injury, or loss of life.

A. This appliance has a pilot which must be lit by hand. When lighting the pilot follow these instructions exactly. If piezo fails, then light the pilot using matches. Refer to the match lighting instructions.

B. **BEFORE LIGHTING** smell all around the appliance area for gas. Be sure to smell next to the floor because some gas is heavier than air and will settle to the floor.

WHAT TO DO IF YOU SMELL GAS:

- * Do not try to light any appliance.
- * Do not touch any electric switch; do not use any phone in your building.
- * Immediately call your gas supplier from a neighbor's phone. Follow the gas supplier's instructions.
- * If you cannot reach your gas supplier, call the fire department.

C. Use only your hand to push in or turn the gas knob. Never use tools. If the knob will not push in or turn by hand, don't try to repair it. Call a qualified service technician. Force or attempted repair may result in a fire or explosion.

D. Do not use this appliance if any part of it has been under water. Immediately call a qualified service technician to inspect the appliance and to replace any part of the control system and any gas control which has been under water.

LIGHTING INSTRUCTIONS

1. **STOP!** Read the safety information on the reverse side of this label.
2. Make sure manual shutoff valve is fully closed. If equipped with thermostat, set to the lowest setting.
3. Turn off all electrical power to the appliance.
4. Push in gas control knob slightly and turn clockwise  to the "OFF."

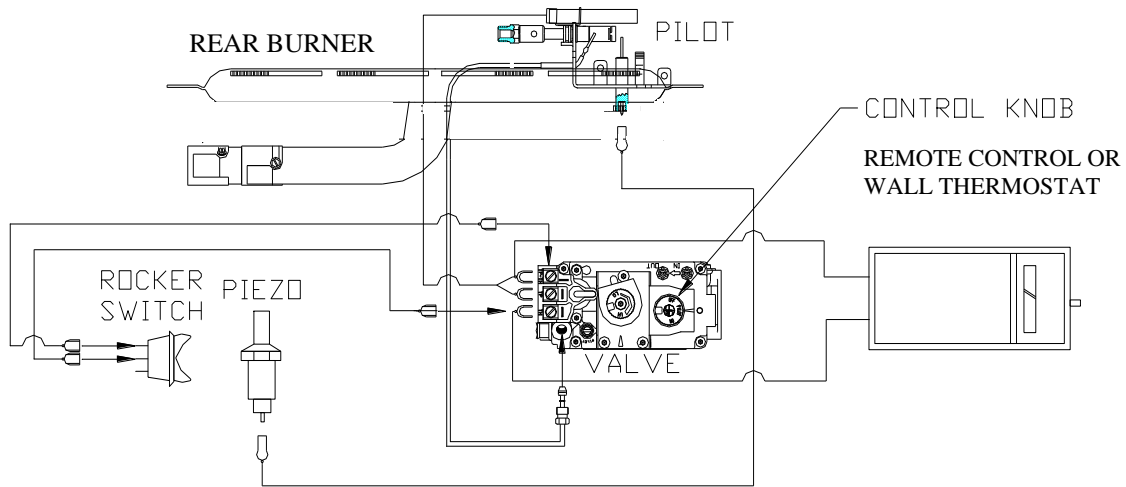

NOTE: Knob cannot be turned from "PILOT" to "OFF" unless knob is pushed in slightly. Do not force.

5. Wait (5) five minutes to clear out any gas. Then smell for gas, including near the floor. If you smell gas, **STOP!** Follow "B" in the safety information on the reverse side of this label. If you don't smell gas, go to the next step.
6. Find Pilot: follow metal tube from gas control. The pilot is located behind the rear burner tube and in front of the rear log. Fully open the manual shutoff valve.
7. Press in and turn knob on gas control counterclockwise  to "PILOT" and continue pressing in the knob for (15) fifteen seconds.
8. With control knob pressed in push down (in) and release the igniter button (igniter button is located on the left hand side of the front of the appliance). This will light the pilot. If needed, keep repeating this step until pilot lights.
9. Keep control knob pressed in for (1) one minute after lighting pilot. After (1) minute, release the control knob and it will pop back up. Pilot should remain lit. If pilot goes out, repeat steps 1 through 9.
- If the knob does not pop up when released, stop and immediately call your service technician or gas supplier.

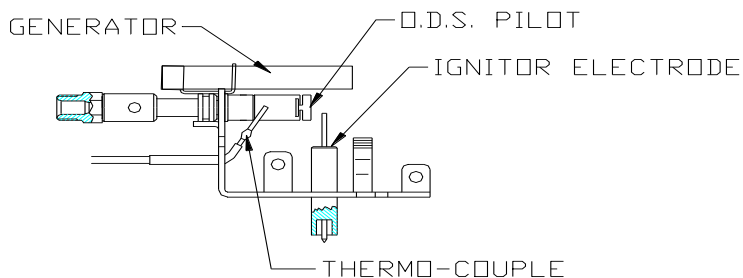

* If the pilot will not stay lit after several tries, turn the gas control knob to “OFF” and call your service technician or gas supplier.

10. Turn control knob counterclockwise  to “ON”.
11. If using unit without wall thermostat place Auto/Off/Manual switch into the manual position. If using wall thermostat place Auto Off Manual Switch into the auto position and place thermostat to a setting higher than the room temperature.
12. Turn on all electrical power to the appliance.
13. Your heater is equipped with a HI & LO control. Turn clockwise for Low and counterclockwise for High.

CAUTION

DO NOT TRY TO ADJUST HEATING LEVELS BY USING THE MANUAL SHUTOFF VALVE.

TO TURN OFF GAS TO APPLIANCE

SHUTTING OFF UNIT

1. If equipped with thermostat set to lowest setting.
2. Turn control knob clockwise  to the “OFF”.
3. Turn off all electric power to the appliance if service is to be performed.

SHUTTING OFF BURNER ONLY (Pilot stays lit.)

1. Turn control knob clockwise  to the “PILOT” position.

CAUTION: Hot while in operation. Do Not Touch. Keep children, clothing, furniture, gasoline, and other liquids having flammable vapors away.

CAUTION: DO NOT TRY TO ADJUST HEATING LEVELS BY USING THE MANUAL SHUTOFF VALVE.

WARNING: Improper installation, adjustment, alteration, service or maintenance can cause property damage, personal injury, or loss of life. Refer to owner’s information manual provided with this appliance. Installation and service must be performed by a qualified installer, service agency, or the gas supplier.

IMPORTANT: Always operate the appliance at the completely “ON” or the completely “OFF” positions. Never use the heater at a setting between these positions as this can result in improper combustion and excessive carbon monoxide emissions.

MANUAL LIGHTING PROCEDURE

1. If the pilot cannot be ignited with the piezo, it can be manually lit with the use of a paper match and lighter rod.
2. Place the match in the holder and light. With the left hand, depress the control knob counterclockwise  to "PILOT". Hold in.
3. Take rod and light match and ignite pilot. The pilot is located behind the right hand side of the front log.
4. Continue to hold the control knob for an additional 1 (one) minute to ensure the pilot is lit.

BURNER & PILOT FLAME CHECK

A periodic check of the flames should be made. The pilot flame should always be present when the gas logs are in operation. See figure below.

Rear Flames: The flames at the rear should be yellow in color, and should extend about 4" to 5" above the large rear log for natural gas logs and about 6" for propane (LP) gas log sets.

Front Flame: The flame should be blue in color and sweeping from bottom of the middle log and producing a red glow on the lugs (burn area). **NOTE:** Allow approximately ten (10) minutes to achieve proper glow on middle log.

EMBERSION 100
24" PINE
LOG SET



EMBERSION 200
30" OAK
LOG SET



PROPER BURNER FLAME

PROPANE

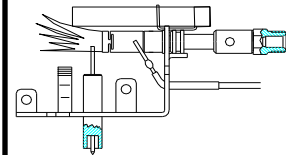

NATURAL

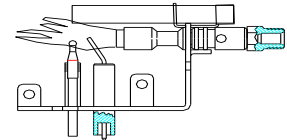

PROPER PILOT
FLAME

WHEN USED AS A HEATING APPLIANCE HEAT OUTPUT

The heat output into the room can be controlled by the position of the flue damper, when used as "vented gas logs". See Section VI - Vented Models.

The heat output is controlled by the "ON/OFF" switch or wall thermostat, not by the control knob. The gas logs are either "ON" or "OFF".

The gas logs may be used as non-vent gas logs only where permitted by local state and city codes. If non-vent gas logs are not permitted, then the fireplace vent area required by local codes must be met. **In the absence of local codes, the latest edition of the National Fuel Gas Code (ANSI Z223.1) must be met.**

SECTION III

INSTALLATION OF LOG SET WITH (OPTIONAL) HEAT SHIELD MODEL 19HS

For installation of gas supply see “Gas Connection” in Section II, page 5.

NOTE: Centrally locate the Heat Shield in the fireplace and place it deep enough into the fireplace to accomplish adequate draft (if use as a vented heater is planned). Ensure that the Heat Shield front is inside the front edge of the fireplace. See Figure 8. Using the screws and anchor provided, fasten the Heat Shield to the floor of the fireplace. On each side of floor frame of Heat Shield base, there is a “go through hole”. Position the Heat Shield as described above. Mark the hole for drilling. See Figure 8.

NOTE: When using Ember Vision 100 Series Log Set with optional Heat Shield the following minimums must be met:

Front 34"-Rear 31"-Height 20"-Depth 20 1/2"

NOTE: When using Ember Vision 200 Series Log Set with optional Heat Shield the following minimums must be met:

Front 36"-Rear 31"-Height 20"-Depth 20 1/2"

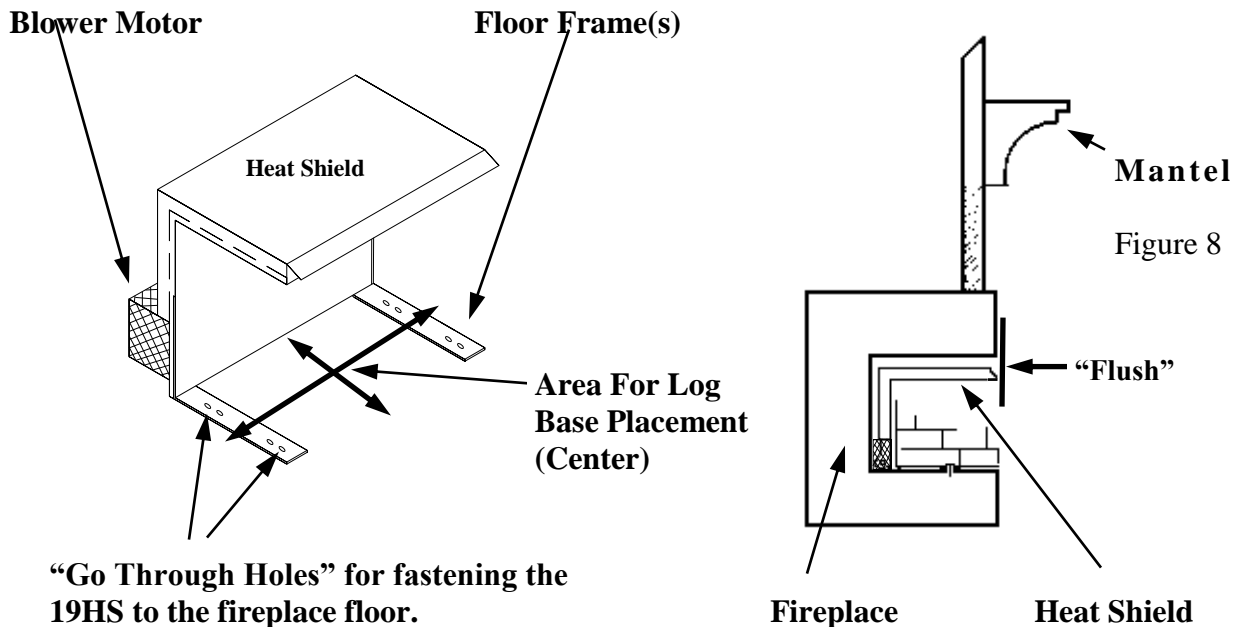

To avoid any movement of the gas log set during operation, screw the base to the floor of the fireplace using the screws provided. Then follow log positioning in Section II.

NOTE: For the first few hours of burning, you will have a paint and burning smell. It is recommended to leave the fan off during this period. You may also want to raise a window or open the doors.

REPLACEMENT PARTS

FOR (OPTIONAL) HEAT SHIELD MODEL 19HS

Always include correct name, part number, and model number of the heater when ordering service parts.

KEY#	PART DESCRIPTION	PART NUMBER
1.	BLOWER Rating: .120 volts/60HZ/ .54 Amps	PE-A2-40-01.
2.	110 THERMOSTAT	PE 400132
3.	CHROME SHIELD	PO HS14
4.	POWER CORD	PE 400240

WARNING: CHILDREN AND ADULTS SHOULD BE ALERTED TO THE HAZARDS OF HIGH SURFACE TEMPERATURES AND SHOULD STAY AWAY TO AVOID BURNS OR CLOTHING IGNITION. YOUNG CHILDREN SHOULD BE CAREFULLY SUPERVISED WHEN THEY ARE IN THE SAME ROOM AS THESE GAS LOGS.

WARNING: Clothing or other flammable material should not be placed on or near this appliance.

WIRING DIAGRAM (For Optional Heat Shield Model 19HS)

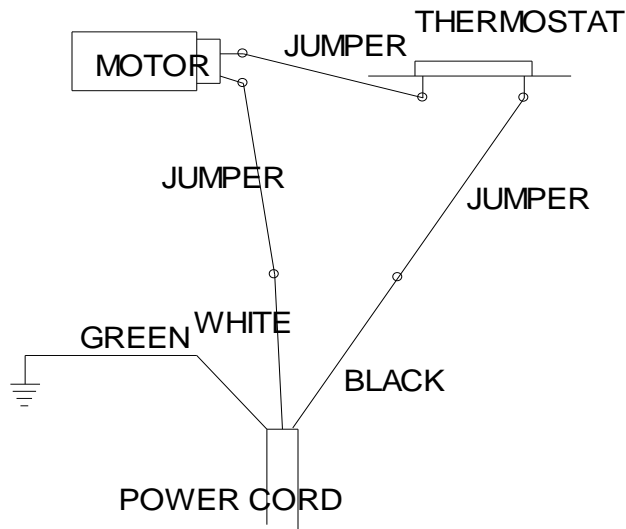

NOTE: If any of the original wire as supplied with the appliance must be replaced, it must be replaced with a wire of at least a 105° C. temperature rating.

NOTE: Installation and repair should be done by a qualified service person. This heater should be inspected before use and at least annually by a qualified service person. More frequent cleaning may be required due to excessive lint from carpeting, bedding material, etc. It is imperative that control compartments and circulating air passageways of the heater be kept clean.

CAUTION: Label all wires prior to disconnection when servicing controls. Wiring errors can cause improper and dangerous operation.

Verify proper operation after servicing.

WARNING: ELECTRICAL GROUNDING INSTRUCTION: THIS APPLIANCE IS EQUIPPED WITH A THREE-PRONG GROUNDING PLUG FOR YOUR PROTECTION AGAINST SHOCK HAZARD. IT SHOULD BE PLUGGED DIRECTLY INTO A PROPERLY GROUNDED THREE-PRONG RECEPTACLE.

WARNING: Do not use a blower insert, heat exchanger insert or other accessories not approved for use with this heater.

WARNING: The motor is permanently lubricated. Do not add any type of lubricant.

SECTION IV

AFTER MARKET MOBILE HOME INSTALLATION

THIS APPLIANCE MAY BE INSTALLED IN AN AFTERMARKET*, PERMANENTLY LOCATED, MANUFACTURED (MOBILE) HOME, WHERE NOT PROHIBITED BY LOCAL CODES. *After Market: Completion of sale, not for the purpose of resale from the manufacturer.

THIS APPLIANCE IS ONLY FOR USE WITH THE TYPE OF GAS INDICATED ON THE RATING PLATE. THIS APPLIANCE IS NOT CONVERTIBLE FOR USE WITH OTHER GASES.

NOTE: For mobile home installation follow “Residential Installation”, Section II, page 4.

SECTION V

PRODUCING ADEQUATE AIR FOR COMBUSTION AND VENTILATION

NOTE: This heater shall not be installed in a room or space unless the required volume of indoor combustion air is provided by the method in the *National Fuel Gas Code, ANSI Z223.1/NFPA 54*, the *International Fuel Gas Code*, or applicable codes.

The National Fuel Gas Code, **ANSI Z223.1/NFPA 54** defines unusually tight construction or unconfined space as a space whose volume is less than 50 cubic feet per 1,000 BTU per hour (4.8m³ per kw) of the aggregate input rating of all appliances installed in that space and an unconfined space as a space whose volume is not less than 50 cubic feet per 1,000 BTU per hour (4.8m³ per kw) of the aggregate input rating of all appliances installed in that space. Rooms communicating directly with the space in which the appliances are installed, through openings not furnished with doors, are considered a part of the unconfined space.

WARNING: IF THE AREA IN WHICH THE HEATER MAY BE OPERATED DOES NOT MEET THE REQUIRED VOLUME FOR INDOOR COMBUSTION AIR, COMBUSTION AND VENTILATION AIR SHALL BE PROVIDED BY ONE OF THE METHODS DESCRIBED IN THE NATIONAL FUEL GAS CODE, ANSI Z223.1/NFPA 54, THE INTERNATIONAL FUEL GAS CODE, OR APPLICABLE CODES.

WARNING: IF THE AREA IN WHICH THE HEATER MAY BE OPERATED IS SMALLER THAN THAT DEFINED AS AN UNCONFINED SPACE OR IF THE BUILDING IS OF UNUSUALLY TIGHT CONSTRUCTION, PROVIDE ADEQUATE COMBUSTION AND VENTILATION AIR BY ONE OF THE METHODS DESCRIBED IN THE NATIONAL FUEL GAS CODE, ANSI Z223.1/NFPA 54 AIR FOR COMBUSTION AND VENTILATION, OR APPLICABLE LOCAL CODES.

Unusually tight construction is defined as construction where:

- a) Walls and ceilings exposed to the outside atmosphere have a continuous water vapor retarder with a rating of 1 perm (6 x 10⁻¹¹ kg per pa-sec-m²) or less with openings gasketed or sealed.
- b) Weather stripping has been added on openable windows and doors.
- c) Caulking or sealants are applied to areas such as joints around window and door frames, between sole plates and floors, between wall-ceiling joints, between wall panels, at penetrations for plumbing, electrical, and gas lines, and at other openings.

NOTICE

SOME AREAS IN THE UNITED STATES HAVE HIGHER REQUIREMENTS FOR CUBIC FEET PER 1000 BTU/ HOUR INPUT. (EX. CINCINNATI, OHIO CODES REQUIRE 70 CUBIC FEET). CHECK YOUR LOCAL CODE BEFORE INSTALLATION.

DETERMINING FRESH-AIR FLOW FOR HEATER LOCATION

DETERMINE IF YOU HAVE UNUSUALLY TIGHT CONSTRUCTION OR UNCONFINED SPACE

Use this worksheet to determine if you have unusually tight construction or unconfined space.

SPACE: Includes the room in which you will install heater plus adjoining rooms with doorless passageways or ventilation grills between the rooms.

1. Determine the volume of the space (length x width x height).

Length x Width x Height = _____ cu.ft.(volume of space)

EXAMPLE: 20 ft.(Length) x 16 ft.(Width) x 8 ft.(ceiling Height)=
2560 cu. ft. (volume of space)

If additional ventilation to adjoining room is supplied with grills or openings, add the volume of these rooms to the total volume of the space.

2. Divide the space volume by 50 cubic feet to determine the maximum BTU/Hr the space can support.

_____ (volume of space)/50 cu. ft. =maximum BTU/Hr the space can support)

EXAMPLE: 2560 cu. ft. (volume of space /50 cu. Ft .= 51.2 or
51200 (maximum BTU/Hr the space can support)

3. Add the BTU/Hr of all fuel burning appliances in the space.

Vent-free heater	_____	BTU/Hr
Gas water heater*	_____	BTU/Hr
Gas furnace	_____	BTU/Hr
Vented gas heater	_____	BTU/Hr
Gas fireplace logs	_____	BTU/Hr
Other gas appliances*	+ _____	BTU/Hr
Total	= _____	BTU/Hr

Example: Gas water heater 40000 BTU/Hr
 Vent-free heater + 18000 BTU/Hr
 Total = 58000 BTU/Hr

*Does not include direct-vent gas appliances. Direct-vent draws combustion air from the outdoors and vents to the outdoors.

4. Compare the maximum BTU/Hr the space can support with the actual amount of BTU/Hr used.

_____ BTU/Hr (maximum the space can support)
 _____ BTU/Hr (actual amount of BTU/Hr used)

Example: 51200 BTU/Hr (maximum the space can support)
 58000 BTU/Hr (actual amount of BTU/Hr used)

The space in the above example is unusually tight construction because the actual BTU/Hr used is more than the maximum BTU/Hr the space can support. You must provide additional fresh air. Your options are as follows:

A. Rework worksheet, adding the space of an adjoining room. If the extra space provides an unconfined space, remove door to adjoining room or add ventilation grills between rooms. See *Ventilation Air For Combustion And Ventilation From Inside Building*, page 23.

B. Vent room directly to the outdoors. See *Ventilation Air For Combustion And Ventilation From Outdoors*, page 24.

C. Install a lower BTU/Hr heater, if lower BTU/Hr size makes room unconfined.

If the actual BTU/Hr used is less than the maximum BTU/Hr the space can support, the space is an unconfined space. You will need no additional fresh air ventilation.

WARNING

**YOU MUST PROVIDE ADDITIONAL
 VENTILATION AIR IN UNUSUALLY TIGHT CONSTRUCTION.**

VENTILATION AIR FOR COMBUSTION AND VENTILATION FROM INSIDE BUILDING

This fresh air would come from an adjoining unconfined space. When ventilating to an adjoining space, you must provide two permanent openings: one within 12" of the ceiling and one within 12" of the floor on the wall connecting the two spaces (See Options 1 and 2, Figure 9). You can also remove door into adjoining room (See Option 3, Figure 9).

WARNING

REWORK WORKSHEET, ADDING THE SPACE OF THE ADJOINING UNCONFINED SPACE. THE COMBINED SPACES MUST HAVE ADEQUATE AMOUNT AIR TO SUPPLY ALL APPLIANCES IN BOTH SPACES.

NOTE: Each opening shall have a minimum free area of 1 square inch per 1000 BTUs per hour of the total input rating of all gas utilization equipment in the confined space, but not less than 100 square inch.

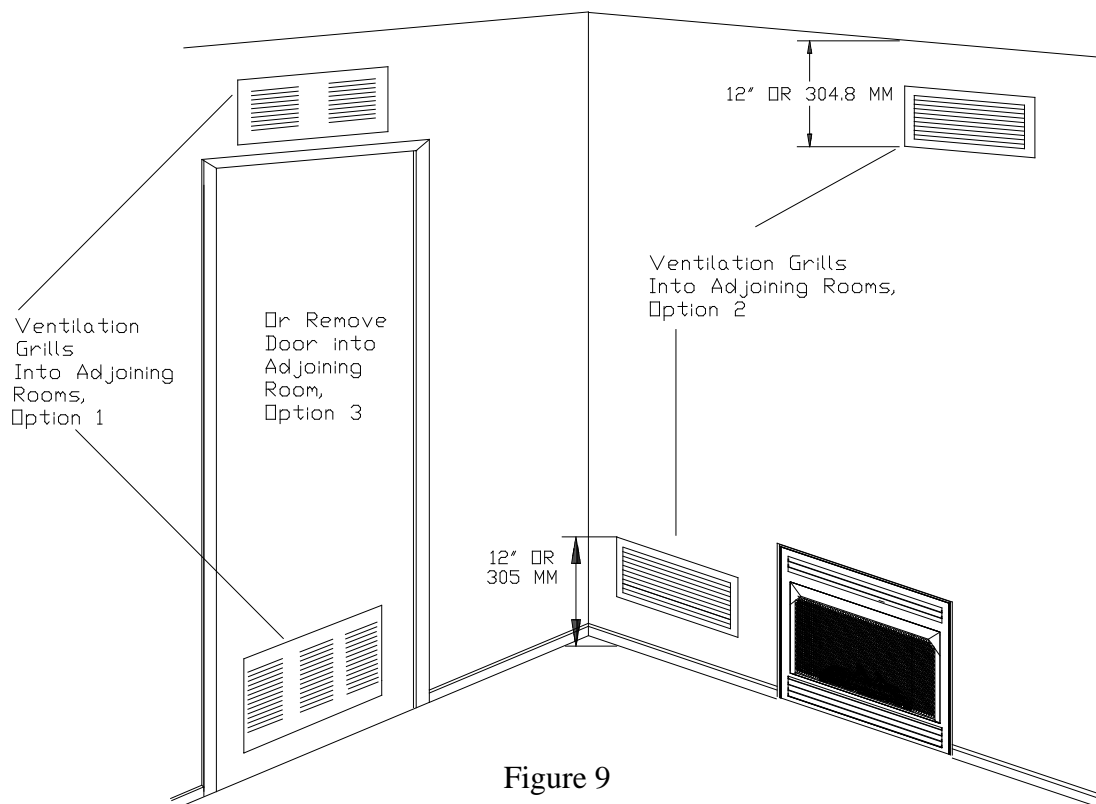

Figure 9

NOTE: This heater shall not be installed in a room or space unless the required volume of indoor combustion air is provided by the method in the *National Fuel Gas Code, ANSIZ223.1/NFPA 54*, the *International Fuel Gas Code*, or applicable codes.

WARNING

THIS HEATER MUST HAVE ADEQUATE AMOUNT OF AIR FOR PROPER OPERATION. IF NOT, POOR FUEL COMBUSTION COULD RESULT. READ THE FOLLOWING INSTRUCTIONS TO ENSURE PROPER AMOUNT OF AIR FOR THIS AND OTHER FUEL-BURNING APPLIANCES IN YOUR HOME.

VENTILATION AIR FOR COMBUSTION AND VENTILATION FROM OUTDOORS

Provide extra fresh air by using ventilation grills or ducts. You must provide two permanent openings: one within 12" of the ceiling and one within 12" of the floor. Connect these items directly to the outdoors. These spaces include attics and crawl spaces. Follow the National Fuel Gas Code **NFPA 54/ANSI Z223.1**, Section 5.3, Air For Combustion and Ventilation for required size of ventilation grills or ducts.

IMPORTANT: Do not provide openings for inlet air into attic if attic has a thermostat-controlled power vent. Heated air entering the attic will activate the power vent.

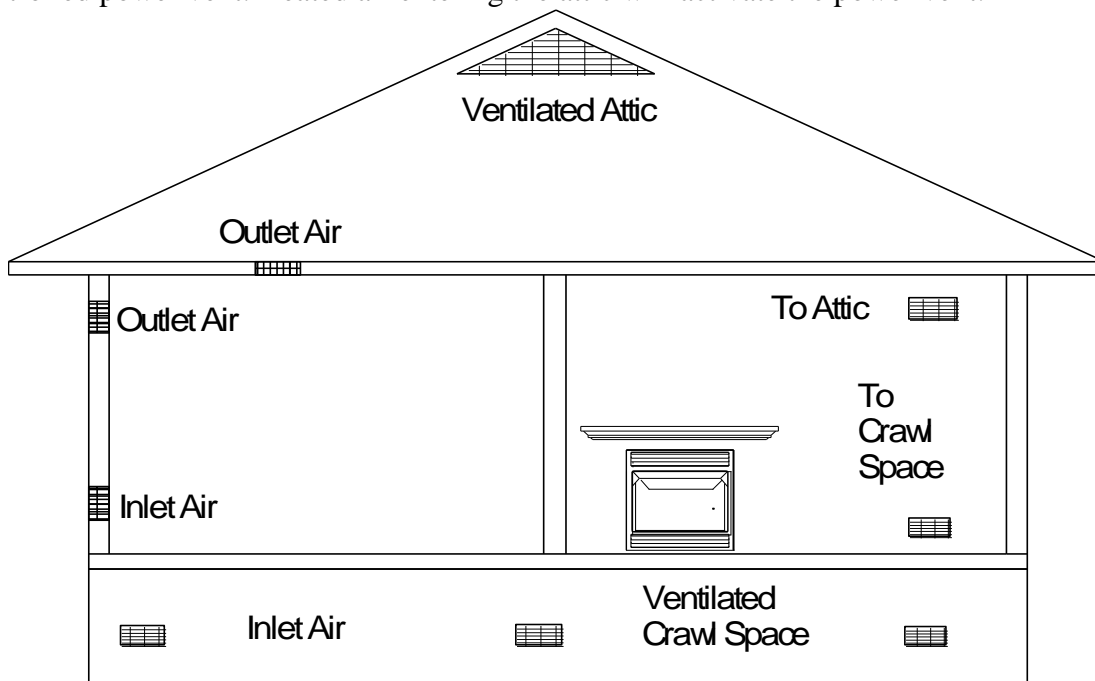
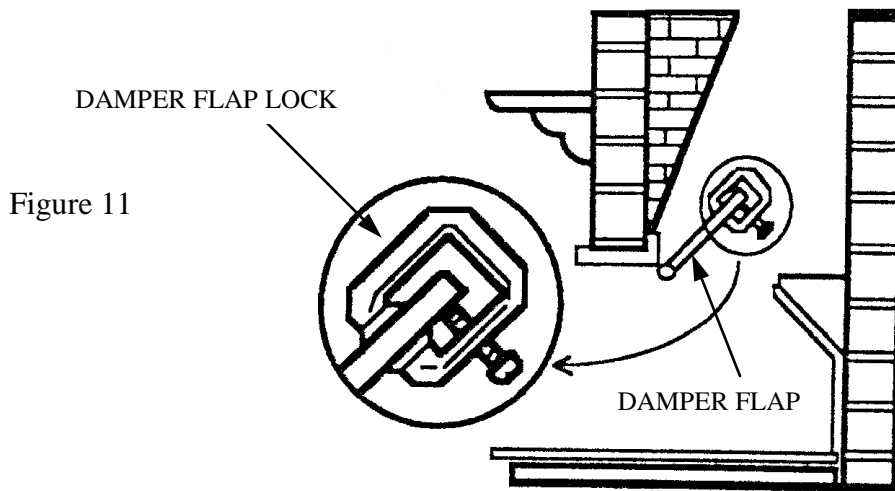

Figure 10

SECTION VI VENTED LOGS

- (1) This appliance must be installed only in a solid-fuel burning fireplace with a working flue and constructed of non-combustible materials.
- (2) A minimum of 34 sq. in. (Min.6' chimney height) (Min. 7" diameter round flue), permanent flue opening must be provided by either the fireplace chimney or chimney damper to vent the flue gases.
- (3) Solid fuels shall not be burned in a fireplace where a decorative appliance is installed.
- (4) Any chimney damper must be fixed in a manner which will maintain the minimum permanent vent opening at all times. This can be accomplished by using a DAMPER FLAP LOCK (shown in figure 11) or by permanently fastening the damper open with screws, or removing the damper flap from the damper opening.



NOTE: See chart on page 26.

MINIMUM FIREPLACE DIMENSIONS FOR EMBER VISION 100 AND 200 LOG SET MANUFACTURED BY NEW BUCK CORPORATION FOR SOLID FUEL BURNING FIREPLACE OR MASONRY FIREPLACE AND PREFAB OR MANUFACTURED FIREPLACES.

MODEL	HEIGHT OF OPENING	WIDTH OF OPENING AT FRONT	WIDTH AT REAR	DEPTH OF FIREPLACE
E.V.24" Logs	17"	32"	26"	15"
E.V.30" Logs	17"	34"	26"	15"

WARNING: A fireplace screen must be in place when the appliance is operating and, unless other provisions for combustion air are provided, the screen shall have an opening(s) for introduction of combustion air.

NOTE: The venting system for this appliance must be checked once a year by a qualified agency to insure that the venting system is clean and free of any obstructions that would decrease the venting capacity of the venting system, which may cause property damage or loss of life.

- (5) See: GAS PRESSURE CHECK, page 10.
- (6) See: OPERATING INSTRUCTIONS, pages 11-13.
- (7) See: BURNER & PILOT FLAME CHECK, for proper flame pattern, page 15.
- (8) See: CLEANING INSTRUCTIONS, page 27.

NOTE: Visually check the pilot and burner flames annually, and monthly during seasons that the appliance is operating frequently. See page 15.

NOTE: The installation of appliances designed for manufactured home (US only) or mobile home installation must conform with the Standard CAN/CSA Z240 MH, Mobile Housing, in Canada, or with the Manufactured Home Construction and Safety Standard, Title 24 CFR, Part 3280, in the United States, or when such a standard is not applicable, ANSI/NCSCS A225.1/NFPA 501A, Manufactured Home Installations Standard.

WARNING: Do not use this appliance if any part has been under water. Immediately call a qualified service technician to inspect the appliance and to replace any part of the control system and any gas control which has been under water.

WARNING: Keep the appliance area clear and free from combustible materials, gasoline and other flammable vapors and liquids.

When using as a vented log set, refer to chart below to calculate minimum damper opening.

FOR MASONRY BUILT FIREPLACES, FREE OPENING AREA OF CHIMNEY DAMPER FOR VENTING COMBUSTION PRODUCTS FROM DECORATIVE APPLIANCES FOR INSTALLATION IN SOLID FUEL BURNING FIREPLACES.

	Appliance Input Rate (kBTU/hr)										
	20	30	40	50	60	70	80	90	100	110	120
Chimney Height* (ft)	Minimum Opening** (sq. in.)										
6	17.6	25.7	33.8	41.7	49.2	56.6	64.0	71.4	78.8	86.2	93.5
8	16.5	23.7	31.2	38.7	45.5	52.4	59.7	66.9	74.1	81.3	88.6
10	15.1	21.7	28.7	35.2	41.7	48.2	54.3	60.2	66.1	72.0	77.9
15	14.1	19.9	26.1	32.0	37.7	43.2	48.8	54.1	59.4	64.6	69.9
20	12.9	18.5	23.7	28.8	34.3	39.8	44.4	49.1	53.8	58.4	63.0
30	12.2	16.9	21.6	26.5	31.2	35.9	40.3	44.5	48.6	52.7	56.6

* Height is from hearth to top of chimney and the minimum height is 6 feet.

** Chart shows minimum opening (sq. in.) for a given height and input rate.

	Appliance Input Rate (kBTU/hr)											
	20	30	40	50	60	70	80	90	100	110	120	
Chimney Height* (ft)	Minimum Opening** (sq. in.)											MAX Input*
10	11.3	16.6	22.1	28.3	35.3	44.2	—	—	—	—	—	77.6
15	8.6	12.6	17.3	21.2	26.4	32.2	38.5	45.4	—	—	—	98.2
20	7.5	10.8	14.5	18.1	22.1	26.4	31.2	37.4	43.0	—	—	114.2
25	6.6	9.6	12.6	15.9	18.1	22.9	27.3	31.2	36.3	43.0	50.3	121.0
30	6.2	9.1	11.3	14.5	17.3	20.4	24.6	28.3	33.2	37.4	44.2	130.1
35	5.7	8.0	10.8	13.2	15.9	18.9	22.1	25.5	30.2	34.2	39.6	141.2
40	5.3	7.5	10.2	12.6	15.2	18.1	20.4	23.8	27.3	31.2	35.3	158.5

* Height is from hearth to top of chimney and the minimum height is 10 feet.

** Chart shows minimum opening (sq. in.) for a given height and input rate.

*** Column marked “Max. Input” corresponds to the maximum allowable input rate (kBTU/hr) for the given height.

IMPORTANT SAFEGUARDS

Although your gas logs are very realistic in appearance, it is not a real burning fireplace and must not be used for burning solid fuel.

To avoid irreparable damage to the heater or personal injury, matches, paper, garbage, or any other material **must not** be placed or thrown on top of the logs or into the flames.

To avoid personal injury, **do not touch hot surfaces** when the heater is operating. Close supervision is necessary when the heater is being operated near children.

WARNING: IN THE EVENT OF THE LOG BEING REMOVED, CARE SHOULD BE TAKEN TO NOT DAMAGE THE LOGS.

THE HEATER IS INTENDED FOR USE AS A GAS HEATER MOUNTED IN A VENTED OR VENT-FREE FIREPLACE AS DESCRIBED IN THESE INSTRUCTIONS. IT SHOULD NOT BE USED FOR ANY OTHER PURPOSE.

CLEANING

CAUTION: BEFORE CLEANING OR MOVING LOGS OR OTHER PARTS OF THE HEATER, BE SURE TO READ THE ABOVE SECTION ON “IMPORTANT SAFEGUARDS”.

Your appliance should be cleaned *at least once a year* to insure proper operation.

All cleaning should be carried out when the heater is cold. Only limited cleaning will be required under normal use. Dusting the front of the base, the top of the piezo cover, or the control knob panel may be required occasionally. **Do not use any cleaning fluids to clean the logs or any other part of the heater.**

If the flames show any unusual shapes or behavior, or if the burners fail to ignite properly, then the burner holes may require cleaning. If this occurs, it is preferable to contact your nearest dealer to get your heater serviced.

Alternatively, the heater can be cleaned by removing the top, front, and rear logs. Handle the logs gently so as not to damage them. Always lift each log by holding it carefully at each end. Use a vacuum cleaner with a soft-brush attachment to carefully remove dust and loose particles from the base, logs, and from around the burners. *NOTE: Never use a sharp object such as a needle or knife to clean the pilot.*

WARNING: Failure to keep the primary air openings(s) of the burner(s) clean may result in sooting and property damage.

TROUBLESHOOTING

WARNING

TURN OFF, UNPLUG HEATER AND LET COOL BEFORE SERVICING. ONLY A QUALIFIED SERVICE PERSON SHOULD SERVICE AND REPAIR HEATER.

CAUTION

NEVER USE A WIRE, NEEDLE, OR SIMILAR OBJECT TO CLEAN ODS/PILOT. THIS CAN DAMAGE ODS/PILOT.

OBSERVED PROBLEM	POSSIBLE CAUSE	SOLUTION
When igniter button is pressed, there is no spark at ODS/PILOT	<ol style="list-style-type: none"> 1. Igniter electrode positioned incorrectly 2. Igniter electrode broken 3. Igniter electrode not connected to igniter cable 4. Igniter cable pinched or wet 5. Piezo igniter nut is loose 6. Broken igniter cable 7. Bad piezo igniter 	<ol style="list-style-type: none"> 1. Replace igniter 2. Replace igniter 3. Reconnect igniter cable 4. Free igniter cable if pinched by any metal or tubing. Keep igniter cable dry. 5. Tighten nut. 6. Replace piezo igniter cable 7. Replace igniter cable
OBSERVED PROBLEM	POSSIBLE CAUSE	SOLUTION
When igniter button is pressed, there is spark at ODS/PILOT but no ignition	<ol style="list-style-type: none"> 1. Gas supply turned off or manual shutoff valve is closed 2. Control knob not in "PILOT" position 3. Control knob not pressed in while in "PILOT" position 	<ol style="list-style-type: none"> 1. Turn on gas supply or open manual shutoff valve 2. Turn control knob to "PILOT" position 3. Press in control knob while in "PILOT" position.

- | | |
|---|--|
| 4. Air in gas lines when installed | 4. Continue to hold down control knob. Repeat igniting operation until air is removed. |
| 5. Depleted gas supply | 5. Contact local propane gas company |
| 6. ODS/PILOT is clogged | 6. Clean ODS/PILOT or replace ODS/PILOT assembly |
| 7. Gas regulator setting is not correct | 7. Replace gas regulator |

**OBSERVED
PROBLEM**

**POSSIBLE
PROBLEM**

SOLUTION

ODS/PILOT lights but flame goes out when control knob is released

- | | |
|---|---|
| 1. Control knob is not fully pressed in | 1. Press in control knob completely |
| 2. Control knob not pressed in long enough | 2. After ODS/PILOT lights keep control knob pressed 30 seconds |
| 3. Safety interlock system has been triggered (if equipped) | 3. Wait 1 minute for safety interlock system to reset |
| 4. Manual shutoff valve not fully open | 4. Fully open manual shutoff valve |
| 5. Thermocouple connection loose at control valve | 5. Hand tighten until snug, then tighten 1/4 turn |
| 6. Pilot flame not touching thermocouple, which allows thermocouple to cool, causing pilot flame to go out. This problem can be caused by one or both of the following:
A) low gas pressure
B) dirty or partially clogged ODS/PILOT | 6. A) Contact local propane gas company
B) Clean ODS/PILOT (See Cleaning and Maintenance), or replace ODS/PILOT assembly |
| 7. Control valve damaged | 7. Replace control valve |

OBSERVED PROBLEM	POSSIBLE CAUSE	SOLUTION
Burner does not light after ODS/PILOT is lit	<ol style="list-style-type: none"> 1. Burner orifice is clogged 2. Inlet gas pressure is too low 	<ol style="list-style-type: none"> 1. Clean burner (see Cleaning and Maintenance) or replace burner orifice 2. Contact local propane gas company
Delayed ignition of burner	<ol style="list-style-type: none"> 1. Manifold pressure is too low 2. Burner orifice is clogged 	<ol style="list-style-type: none"> 1. Contact local propane gas company 2. Clean burner (see Cleaning and Maintenance) or replace burner orifice
Burner backfiring during combustion	<ol style="list-style-type: none"> 1. Burner orifice is clogged or damaged 2. Burner damaged 3. Gas regulator defective 	<ol style="list-style-type: none"> 1. Clean burner (see Cleaning and Maintenance) or replace burner orifice 2. Replace burner 3. Replace gas regulator
Slight smoke or odor during initial operation	<ol style="list-style-type: none"> 1. Residues from manufacturing process 	<ol style="list-style-type: none"> 1. Problem will stop after a few hours of operation
Heater produces a whistling noise when burner is lit	<ol style="list-style-type: none"> 1. Turning control knob to “HI” position when burner is cold (if equipped with this type of valve) 2. Air in gas line 3. Air passageways on heater blocked 4. Dirty or partially clogged burner orifice 	<ol style="list-style-type: none"> 1. Turn control knob to “LOW” position and allow to warm for a minute 2. Operate burner until air is removed from line. Call local propane company to check gas line. 3. Observe minimum installation clearances 4. Clean burner or replace orifice

WARNING

IF YOU SMELL GAS:

- * **SHUT OFF GAS SUPPLY**
- * **DO NOT TRY TO LIGHT APPLIANCE**
- * **DO NOT TOUCH ANY ELECTRICAL SWITCH; DO NOT USE ANY PHONE IN YOUR BUILDING**
- * **IMMEDIATELY CALL YOUR GAS SUPPLIER FROM A NEIGHBOR'S PHONE. FOLLOW THE GAS SUPPLIER'S INSTRUCTIONS.**
- * **IF YOU CANNOT REACH YOUR GAS SUPPLIER, CALL THE FIRE DEPARTMENT.**

IMPORTANT: Operating heater where impurities in the air exist may create odors. **Cleaning supplies, paint, paint remover, cigarette smoke, cements and glues, new carpet or textiles, etc. create fumes. These fumes may mix with combustion air and create odors.**

OBSERVED PROBLEM	POSSIBLE CAUSE	SOLUTION
Heater produces a clicking/ticking noise just after burner is lit or shut off	1. Metal expands while heating or contracts while cooling	1. This is common with most heaters. If noise is excessive, contact a qualified service person.
Heater produces unwanted odors	1. Heater burning vapors from paint, hair spray, glues, etc. (See “ Important ” above) 2. Low fuel supply 3. Gas leak (See “ WARNING ” above)	1. Ventilate room. Stop using odor causing products while heater is running. 2. Refill supply tank. 3. Locate and control all leaks. See “Checking Gas Connections”.
Heater shuts off in use (ODS operates)	1. Not enough fresh air is available 2. Low line pressure 3. ODS/PILOT is partially clogged	1. Open window/door for ventilation 2. Contact local propane company 3. Clean ODS/PILOT
Gas odor even when control knob is in OFF position	1. Gas leak (See “ WARNING ” above) 2. Control valve defective	1. Locate and correct all leaks (see Checking Gas Connections) 2. Replace control valve

**OBSERVED
PROBLEM****POSSIBLE
CAUSE****SOLUTION**

Gas odor during combustion

1. Foreign matter between
control valve and burner1. Take apart gas tubing and
remove foreign matter2. Gas Leak. See
“WARNING” statement at top
of previous page2. Locate and correct all leaks
(See “Checking Gas
Connections”)

NOTE: You may want to have your chimney cleaned by a professional before installing unit.

SERVICING

Repair and replacement work should only be done by a qualified service person.

Always shut off the gas supply and make sure that heater is cool before beginning any service operation. **Always check for gas leaks after servicing.**

REPLACEMENT PARTS

A parts list with exploded view follows. Always include correct name, part number, and model number of the heater when ordering service parts.

KEY#	PART DESCRIPTION	PART NUMBER
	SIT - MILLIVOLT	
1.	O.D.S. PILOT (L.P.) O.P. ASSEMBLY	PE 8404C
1.	O.D.S. PILOT (NAT) O.P. ASSEMBLY	PE 8204C
2.	GENERATOR ASSEMBLY	(Part of Pilot Assembly)
3.	PILOT TUBE 3/16"	MF 31612 ALMTUB
4.	GENERATOR WIRE	(Part of Pilot Assembly)
5.	REAR BURNER	PO VE1002
	FRONT BURNER	PO VE1001
6.	INLET ELBOW	PH 4966
7.	3/8" COMP. NUT & SLEEVE	PH 616 & PH 606
8.	3/8" BURNER SUPPLY TUBE (FLEX)	
	- 2 pieces 12"	PO T6-12
9.	24" SWITCH WIRES	PE 30JUMPER
10.	CARLING SWITCH	
	(AUTO/OFF/MANUAL)	PE RC211RB
11.	PIEZO STRIKER	PE 124461
12.	PIEZO 18" IGNITOR WIRE	PE 8400-014
13.	MALE RUN TEE FITTING	PH 64A-66
14.	THERMO-COUPLE	
15.	MANIFOLD OUTLET CONNECTOR	PH 68A-6C
16.	ORIFICES <u>L.P.</u>	
	REAR #1.35mm	PO 135 MVORF
	FRONT #54	PO 54 MVORF
	<u>NATURAL</u>	
	REAR #43	PO 43 MVORF
	FRONT #46	PO 46 MVORF
17.	820 mv. S.I.T. VALVE	LP - PE 820-636
		NAT - PE 820-637
18.	8"L 3/8"BURNER SUPPLY LINE	MF382ALMTUB
	(3/4"-3/8" FLARE/3/8" COMP. N&S FITTINGS)	
OPTIONAL	CANOPY (HOOD)	MAPSFPC002
*	OAK LOG SET	24" EMBER VISION CERAMIC
*	PINE LOG SET	24" EMBER VISION FIBER
*	OAK LOG SET	30" EMBER VISION CERAMIC

REPAIR PARTS

A parts list with exploded view follows. Always include correct name, part number, and model number of the heater when ordering service parts. Please contact your local dealer or distributor when ordering . If one is not available, you may contact.

New Buck Corporation
200 Ethan Allen Drive, P.O. Box 69
Spruce Pine, NC 28777

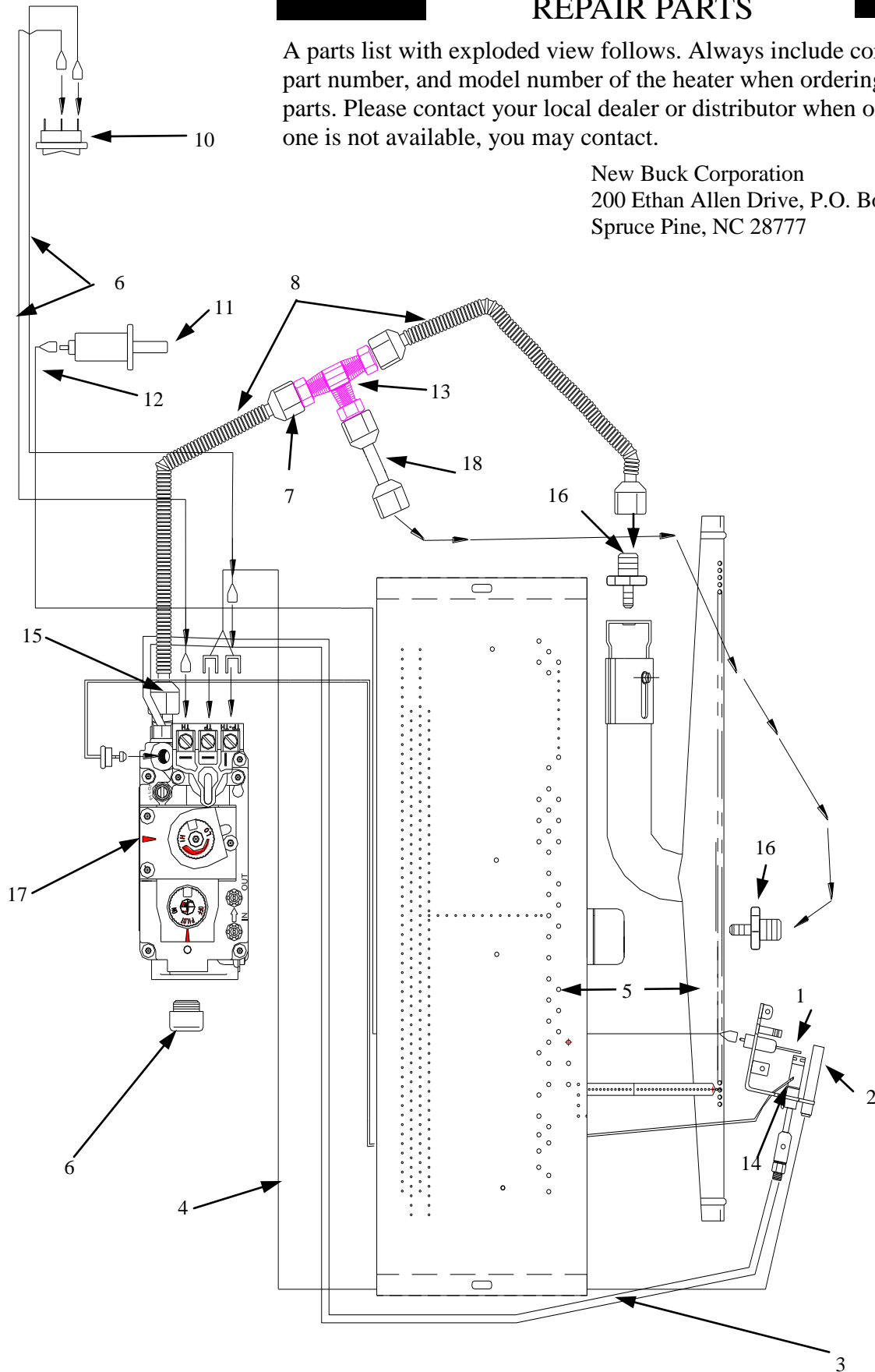

NEW BUCK CORPORATION
200 ETHAN ALLEN DRIVE • P.O. BOX 69
SPRUCE PINE, NC 28777

We reserve the right to amend these specifications at any time without notice. The only warranty applicable is our standard written warranty. We make no other warranty, expressed or implied.

LIMITED WARRANTY
VENT-FREE AND VENTED GAS LOGS

New Buck warrants this product to be free from defects in materials and components for two (2) years from the date of first purchase, provided that the product has been properly installed, operated and maintained in accordance with all applicable instructions. To make a claim under this warranty the Bill of Sale or canceled check must be presented.

This warranty is extended only to the original retail purchaser. This warranty covers only the cost of part(s) required to restore this heater to proper condition. Warranty part(s) MUST be obtained through authorized dealers of this product and/or New Buck who will provide original factory replacement parts. Failure to use original factory replacement parts voids this warranty. The heater MUST be installed by a qualified installer in accordance with all local codes and instructions furnished with the unit.

This warranty does not apply to parts that are not in original condition, because of normal wear and tear, or parts that fail or become damaged as a result of misuse, accidents, lack of proper maintenance or defects caused by improper installation.

What is not covered:

- * Removal and re-installation costs.
- * Labor costs for replacement or repairs.
- * Transportation or labor costs.
- * The cost of a service call to diagnose trouble.
- * Painted surfaces.
- * Damage or defect caused by improper installation, accident, misuse, abuse, or alteration.

TO THE FULL EXTENT ALLOWED BY THE LAW OF THE JURISDICTION THAT GOVERNS THE SALE OF THE PRODUCT, THIS EXPRESS WARRANTY EXCLUDES ANY AND ALL OTHER EXPRESSED WARRANTIES AND LIMITS THE DURATION OF ANY AND ALL IMPLIED WARRANTIES, INCLUDING WARRANTIES OF MERCHANTABILITY AND FITNESS FOR A PARTICULAR PURPOSE TO ONE (1) YEAR FROM THE DATE OF FIRST PURCHASE. NEW BUCK LIABILITY IS HEREBY LIMITED TO THE PURCHASE PRICE OF THE PRODUCT AND NEW BUCK SHALL NOT BE LIABLE FOR ANY OTHER DAMAGES WHATSOEVER INCLUDING INDIRECT, INCIDENTAL OR CONSEQUENTIAL DAMAGES.

Some states do not allow a limitation on how long an implied warranty lasts or an exclusion or limitation of incidental or consequential damages, so the above limitation on implied warranties, or exclusion or limitation on damages may not apply to you.

This warranty gives you specific legal rights, and you may also have other rights that vary from state to state.

OWNER REGISTRATION

The attached owner registration card must be completed in its entirety and mailed within 30 days from date of installation in order for warranty coverage to begin to:

New Buck Corporation
P.O. Box 69
Spruce Pine, NC 28777
Email: info@buckstove.om

PLEASE NOTE: Owner Registration Card must contain Authorized Buck Stove Dealer Number and Certified Installer's number (if applicable) for warranty coverage to begin.

<p>NAME: _____</p> <p>ADDRESS: _____</p> <p>CITY: _____</p> <p>STATE: _____ ZIP: _____</p> <p>CUSTOMER EMAIL: _____</p> <p>MODEL #: _____</p> <p>SERIAL #: _____</p> <p>DATE OF PURCHASE: _____</p> <p>DATE OF INSTALLATION: _____</p> <p>INSTALLER'S NAME: _____</p> <p>PURCHASED FROM: _____</p>
--